

SPECIFICATION

For

SWITCHING POWER SUPPLY

- **SNP-S063**
- SNP-S063-H

STANDARD PRODUCT

All Rights Reserved

Reviewed by	Jim					
Product Engineer	12-12-23					
Typed by	李岩					
Document Assistant	120922					
SKYNET ELECTRONIC			LAST REV. NO.			

1.0 INTRODUCTIONS

SNP-S063series is an open frame 54W power supply without heat conduction pad, and SNP-S063H is 60W with heat conduction pad. Both are built-in:

- (1) Peak load (1.6 x rated current, V_o =rated for 8 sec)
- (2) Meet 2 x MOPP, Earth leakage current < 300uA and Touch current < 100uA for BF application
- (3) for home healthcare application, input class II and EMI class B
- (4) -40°C to +70°C operating temperature
- (5) 5,000m operation altitude

2.0 INPUT SPECIFICATIONS

2.1 Input voltage

Input voltage range : 90Vac to 264Vac
Nominal line voltage : 115Vac/230Vac

2.2 Input frequency

47Hz to 63Hz

2.3 Input current

2A_{rms} max/115Vac, 1A_{rms} max/230Vac

2.4 Inrush current

30A max/115Vac, 60A max/230Vac (EMI capacitors excluded, cold start at 25°C)

3.0 OUTPUT SPECIFICATIONS

All specs under item 3.0 except with special notes are defined and tested at nominal line input, rated load and 25°C

3.1 Load range

V_o	rated load	peak load	voltage range
+5V	4.0A	6.4A	4.75V~5.25V
+12V	3.33A	5.33A	11.4V~12.6V

3.1.1 Factory adjustment

+4.95V to +5.05V (60% rated load, 115Vac)

3.1.2 Peak load max duration

8sec. (duty cycle < 50%, average power < rated power)

3.1.3 Total rated power

Total rated power is limited to 54W.

3.2 Ripple and noise

< 1% (20MHz bandwidth limited, 1X probe with 0.47uF parallel capacitor)

3.3 Line regulation

< ±1% (90Vac to 264Vac, compare with 115Vac)

3.4 Load regulation

< ±3% for +5V&+12V (20% to 100% rated load, compare with 60% rated load)

4.0 GENERAL FEATURES

All specs under item 4.0 except with special notes are defined and tested at nominal line input, rated load and 25°C

4.1 Efficiency

> 82% typ.

4.2 Hold up time

15 ms typical

4.3 Protection

4.3.1 Over-voltage protection

Trip point : +5.7V to +7.0V

Protection mode : Latch-off

4.3.2 Short circuit and over-load protection

Protection mode : Auto-recovery

5.0 ENVIRONMENT SPECIFICATIONS

5.1 Operating temperature

-40°C to 70°C (>50°C with derating as below.)

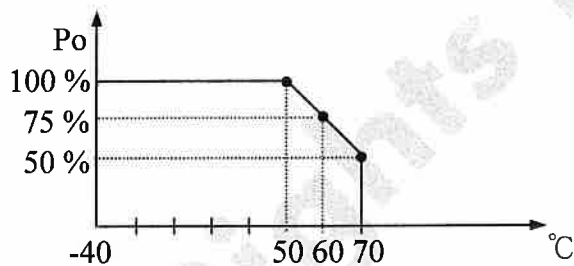

5.2 Storage temperature

-40°C to 85°C

5.3 Operating humidity

5% to 95% RH, non-condensing

5.4 Altitude

0 to 5000m

6.0 INTERNATIONAL STANDARDS

6.1 Safety standards (Label voltage: 100Vac to 240Vac)

Designed to meet the following regulations :

UL/CSA/EN/IEC 62368-1

ANSI/AMMI/CSA/EN/IEC 60601-1,3.1 edition

6.2 EMI standards

FCC docket 20780 curve "B"

EN55032, level "B"

EN55011, level "B"

EN 61000-3-2 class "A"

EN 61000-3-3

6.3 EMS standards

EN61000-4-2	8kV/contact discharge, 15kV/air discharge	Criterion A
EN61000-4-3	10V/M with 80% AM	Criterion A
EN61000-4-4	4kV	Criterion A
EN61000-4-5	2kV/Line-Line,	Criterion A
EN61000-4-6	10V with 80% AM	Criterion A
EN61000-4-8	30A/m	Criterion A
EN61000-4-11	100% dips 10ms,	Criterion A
	100% dips 20ms,	Criterion B
	30% dips 500ms,	Criterion A
	60% dips 200ms,	Criterion B
	100% dips 5000ms,	Criterion B

7.0 MECHANICAL SPECIFICATION

7.1 Dimensions

Dimensions below are shown in mm[inch]. Tolerance specified is + -0.4mm[0.016].

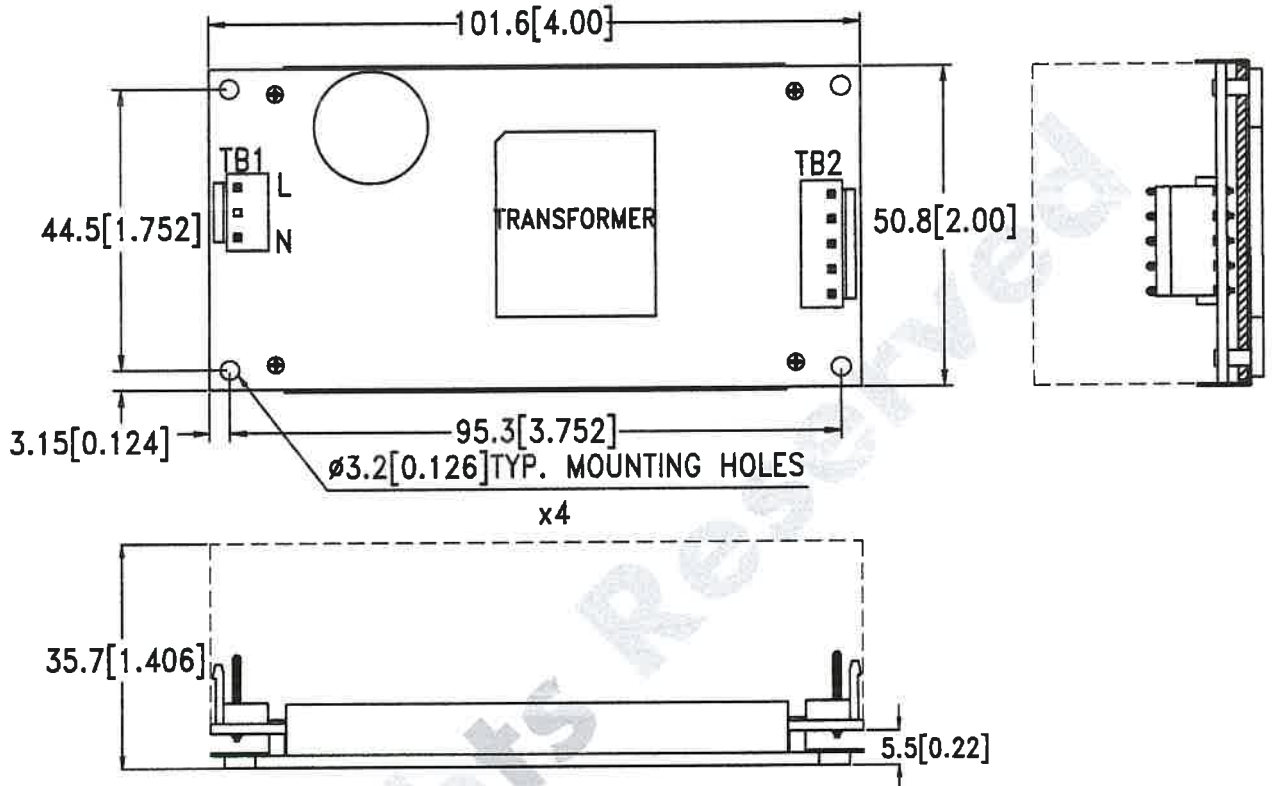

7.2 Connectors

TB1--AC Input : JST B2P3-VH or TKP PVHI-03N2
 (Mating Housing : JST VHR-3N or TKP HVH-03)

TB2--DC Output : JST B5P-VH or TKP PVHI-05
 (Mating Housing : JST VHR-5N or TKP HVH-05)

7.3 DC Output pin assignment

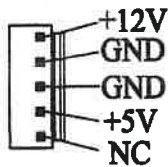

7.4 Packing

- Net weight : 164 g approx. / unit
- Carton size (mm) : 387 (L) x 327 (W) x 277 (H)
- Quantity : 60 units / carton
- Gross weight : 12.4 kg approx. / carton

8.0 APPLICATION NOTE

8.1 For Class II connection

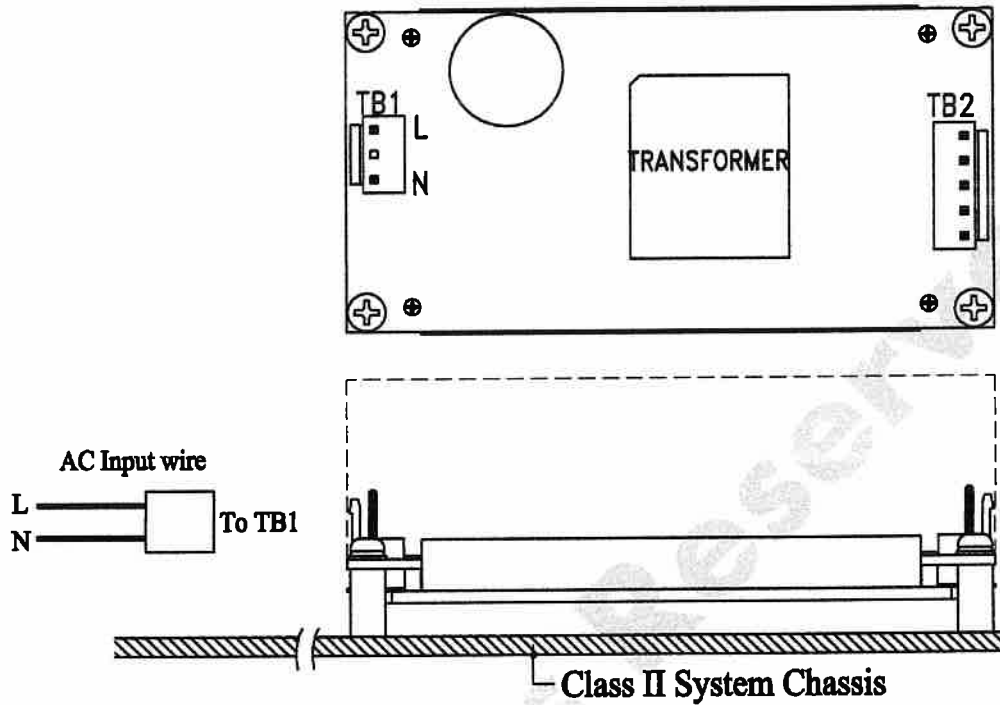

8.2 Output power conditions

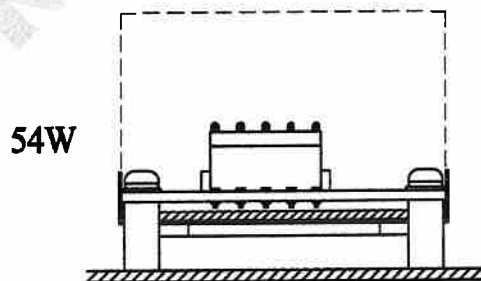

1. When the product case is not attached to the system chassis, and the output power is 54W.

9.0 PERFORMANCE (input voltage is 115VAC, unless others specified)

9.1 Switching frequency ripple

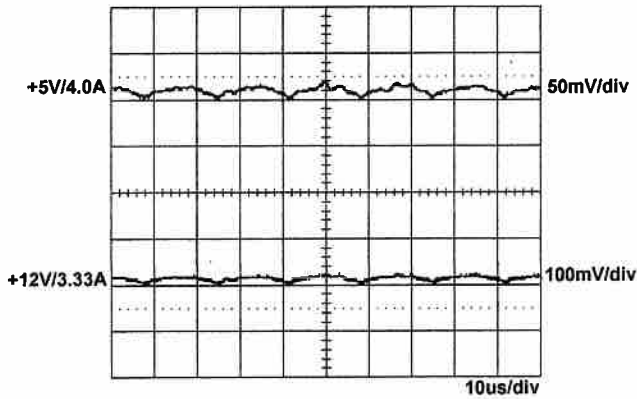

9.2 Line frequency ripple

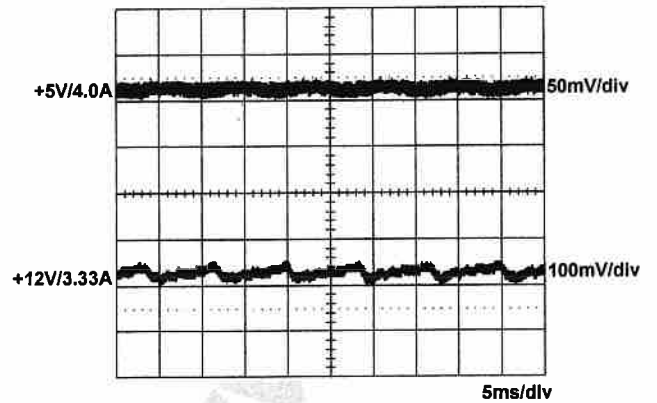

9.3 Output turn on wave form

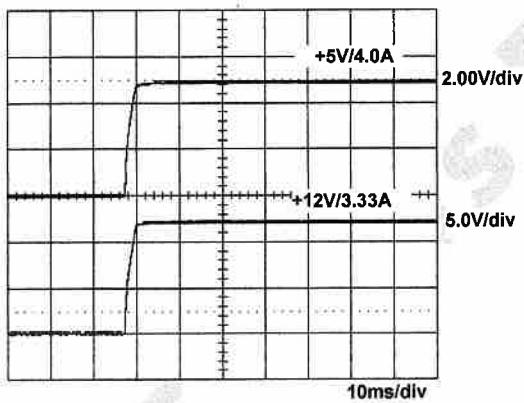

9.4 Output turn off wave form

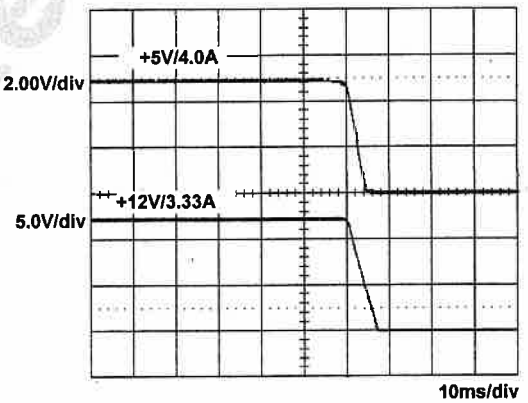

9.5 Hold-up time

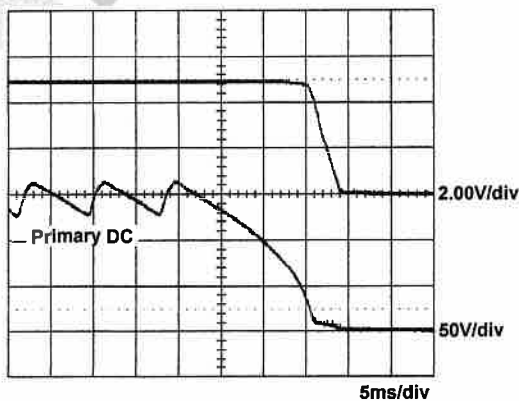

9.6 Over voltage protection

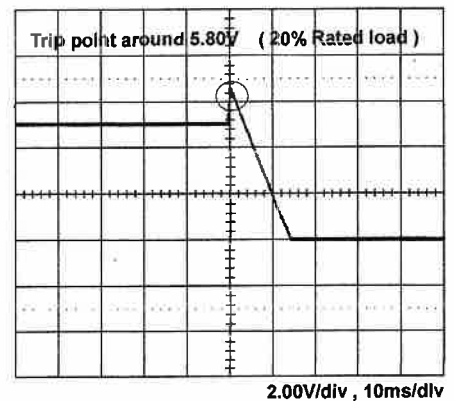

9.7 +5V step response

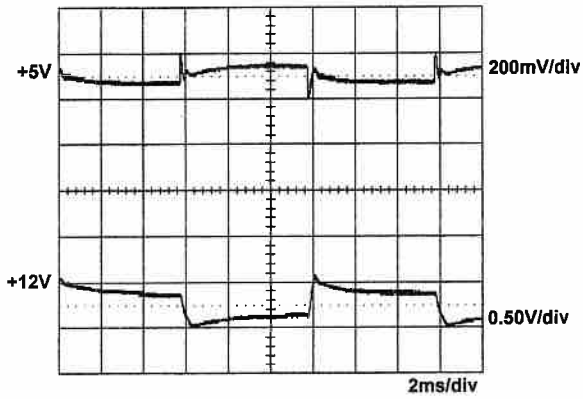

+5V step from 0.80A to 4.0A
other output at 60% load

9.8 +12V step response

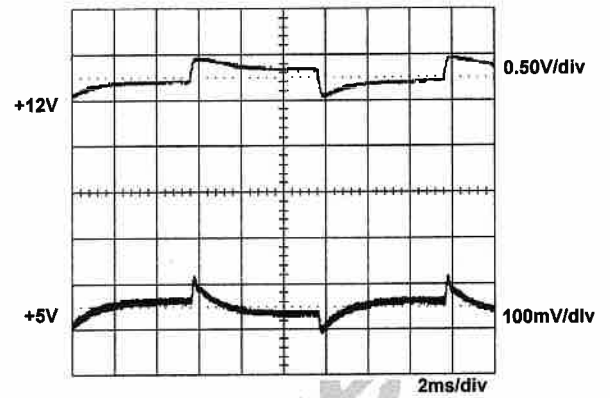

+12Vsb step from 0.67A to 3.33A
other output at 60% load

9.10 peak load

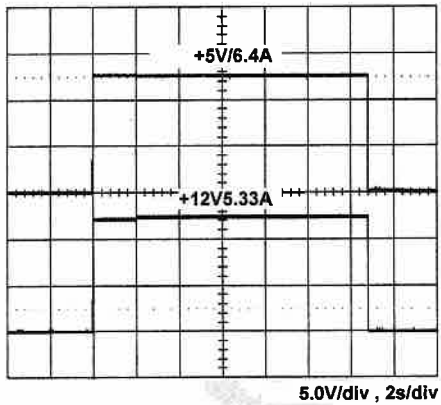

9.11 FCC "B"

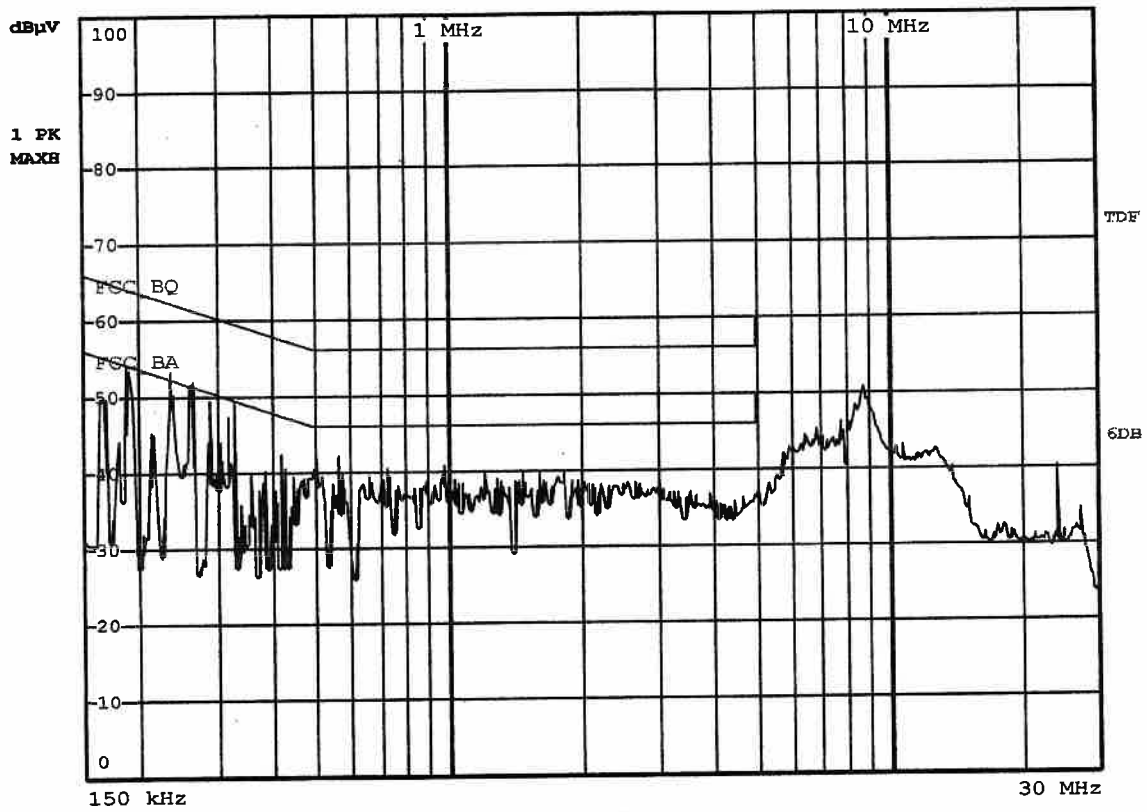

9.12 CISPR "B"

